

**Durable,
Long-lasting
Punches &
Punch Blanks**

TUFFPUNCH[®]



Global leader in
providing fabrication
and stamping solutions

a MISUMI Group Company

www.daytonprogress.com

**Heads-
above-the-rest
performance**



TuffPunch® Heavy-Duty Punches and Punch Blanks



Product Applications

Dayton Progress **TuffPunch® Punches** and **Punch Blanks** are Kommercial quality products manufactured with thicker, larger, 10° angled diameter heads, and are designed to reduce punch load and significantly lower failure rates when using heavy gauge and high tensile material. TuffPunch® products are well-suited for high-demand industries where frequency and heavier-than-normal impact punching activity occurs and where optimum performance is required.

Dayton's TuffPunch® product line includes: **Dayton Jektole® Punches; Regular Punches;** and **Punch Blanks**. Both standard sizes and standard alterations are shown in this catalog.

Unique Head Design

All Dayton TuffPunch® products are designed with a 10° angled head with a diameter equal to the shank diameter (see photo). This design allows the perforating forces to travel up from the shank and completely through the head. This eliminates the lateral shock waves that would otherwise put stress on the outer edge of the head, resulting in frequent failures—especially in heavy-duty applications.

In addition, Dayton TuffPunch® products are available in *common shear angle configurations* to reduce punch load and minimize the risk of slug pulling. Shear angle configurations include: nail point; chamfer; conical; double shear; and single shear. For more information, see "Standard Alterations" on p. 6.

Cryogenic Treatment Standard

DayKool™ (XCR)—a cryogenic steel conditioning process used primarily with hard, thick materials to improve strength, toughness, and dimensional stability—is standard on all Dayton TuffPunch® products.

The DayKool™ process utilizes a liquid nitrogen vapor to cool the steel to -300° F, which creates metallurgical changes in the structure that disperse carbides throughout the metal. The result: increased wear resistance (finely dispersed carbides provide more evenly distributed wear); less sharpening time; no loss of resistance after sharpening; longer die runs; and less downtime.

Surface Coatings

Punches can be coated to increase material hardness, reduce galling, and improve wear/and or corrosion resistance.

Surface Treatments

DayTride® (XN)—A low temperature, cost-effective surface application that treats all exposed surfaces. Provides increased dimensional stability. Ideal for punches and die buttons. Approx. hardness: RC73.

XVP—A thin film coating provides superior hardness (harder than carbide). Super-smooth finish on the point helps reduce galling and maintenance. Ideal for higher-than-normal punching frequency.

XPS—Super-smooth polish on the point to reduce galling and improve punch life. Use with the appropriate coating for your application to maximize punch life and reduce maintenance costs. Excellent for extruding applications.

Abrasive Wear

DayTiN® (XNT)—Excellent wear resistance and lubricity. Not recommended for stainless steel, copper, or nickel. A good general-purpose coating. Approx. hardness: *Vickers 2300.

TiCN (XCN)—Ultra-hard (harder than carbide), thin coating. Provides superior abrasive wear resistance and lubricity. A very good general-purpose coating for all materials. Upgrade over XNT. Approx. hardness: *Vickers 3000.

DayTAN™ (XAN)—Ultra-hard (harder than carbide), high-aluminum coating. Provides high temperature resistance. Well-suited for applications where surface heat is generated. Ideal for HSLA, dual phase, and TRIP steels. Upgrade over XCN. Approx. hardness: *Vickers 3400.

ZertonPlus™ (XNA)—Superior hardness (harder than carbide); provides superior abrasive wear resistance and excellent lubricity. Provides highest temperature resistance, thermal shock stability, & hot hardness. Approx. hardness: *Vickers 3200.

Adhesive Wear

XNM—A solid lubricant coating. Provides both lubricity and wear resistance not available from other PVD or CVD processes. Ideal for aluminum, copper, pre-painted, and galvanized steels. Approx. hardness: *Vickers 2000.

XANL—High hardness and temperature resistance of XAN coating topped with an anti-frictional coating with excellent lubrication properties. Approx. Hardness: Vickers 3000.

XCD—Diamond-like carbon coating. Combines high hardness with an extremely low coefficient of friction. Good protection against abrasive and adhesive wear. Ideal for aluminum. Approx. hardness: *Vickers 5000.

XCDH—Super-smooth finish combined with advanced DLC coating for a very low coefficient of friction with extremely high wear resistance. Approx. hardness: *Vickers 5000.

XCDP—Super-smooth finish combined with a DLC coating for a very low coefficient of friction with high wear resistance. Excellent for stamping aluminum. Approx. Hardness: Vickers 2800.

Extrusion Coatings

XNP—The ultimate coating for improved resistance to galling; excellent wear resistance, superior surface finish, and high lubricity. Ideal for extruding and forming applications. Tolerance is ±.0002". Approx. hardness: *Vickers 3100.

XNAProgress (XNAP)—Ultra-hard coating that absorbs shear stress; provides excellent high-temperature resistance. Ideal for stamping where tools are exposed to extreme stress profiles. A good alternative to TD coating without the dimensional changes associated with that process. Approx hardness: *Vickers 3200.

Miscellaneous Coating

CRN—Excellent adhesion, high toughness, and good corrosion resistance. Primary applications are metal forming (copper, brass, & bronze), metal die casting, and plastic injection molding. Approx. hardness: *Vickers 1800-2100.

Special Features

There are several features that contribute to minimize failures. In addition to the head design and large fillet (.040"-.060" radius) under the head, all punch shapes with sharp corners will have a carefully blended .005" radius ground to reduce loading on the punch. The reduced load and standard cryogenic treatment result in fewer punch point problems caused by chipping, wear, or breakage.

*Vickers used when RC exceeds 80.

Ordering Information

Each page contains detailed instructions on how to order specific Dayton TuffPunch® products. Individual drawings show product shape, dimensions, tolerances, and concentricity. When ordering, you are asked to specify quantity, type, shank and length codes (for example), and other applicable data.

HOW TO ORDER

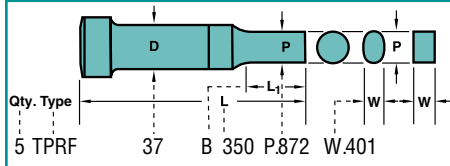

In the example above, the type specified is "TPRF." "T" stands for TuffPunch®, "P" stands for punch, and "R" stands for rectangle. "F" is an additional product code. 37 is the press-fit diameter, which is coded by the first two digits of the decimal equivalent (.375). B350 stands for the point and overall length with the "B" as the code for .75" point length and 350 as the code for punch length in inches (three and one-half inches). Finally, P.872 and W.401 represent the point or hole size dimensions.

Standard Alterations

Punches and punch blanks are available in sizes other than those listed in the catalog. These special order products can be manufactured for a slight additional charge.

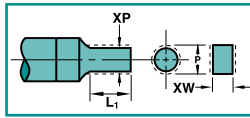

When ordering, you are asked to specify different designations

for various non-standard dimensions. For example, if the P & W dimensions are smaller than standard, an "X" must be placed in front of the P or W dimensions, e.g., "XP" and "XW." If the point length is longer than standard, designate "XBR(L1)" for the point length. The sample drawing above is from the "Standard Alterations" section on p. 6.

Other special order designations include: "XL" for overall length shortened; "XK" for no side hole and no components (for air ejection of slugs); and special designations for surface treatments and coatings.

Product Designation

When ordering, you are asked to specify quantity, product type, length codes, and point or hole size (for example). In addition, use the following chart to define the product as a part number.

Description

TPRF	Line	T for TuffPunch®
	Product Shape	P for Punch (Regular) R for Rectangle F is additional product code
75	Press-Fit Dia. D (shank diameter)	First 2 digits of decimal equivalent (.750)
L1	Point Length	
350	Overall Length L	Whole number and first two digits of decimal equivalent (3.500)
TPRF	Product Series	Length
75	75	350
B	B	P.872, W.401
Type	Catalog Number	Dimensions As Specified

Diameter (D) is shown on the order as a two-digit code. To convert the shank diameter to the appropriate code, use the following chart.

Code	D	Code	D
37	.3750	75	.7500
43	.4375	87	.8750
50	.5000	100	1.0000
62	.6250		

TuffPunch®, DayKool™, DayTAN™, ZertonPlus™, Daytride® and DAYTIN® are trademarks of Dayton Progress Corp.

TuffPunch® Retainers



KRTF
for round punches
KRTFS
for shape punches

TuffPunch® retainers offer precise dowel locations allowing CNC machining of the punch and die plates. The dimensional accuracy also permits interchangeability of retainers that before could not have been done without plugging holes and re-machining for dowels.

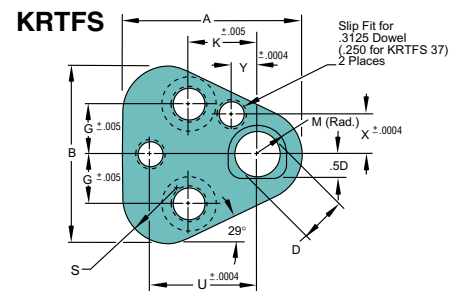
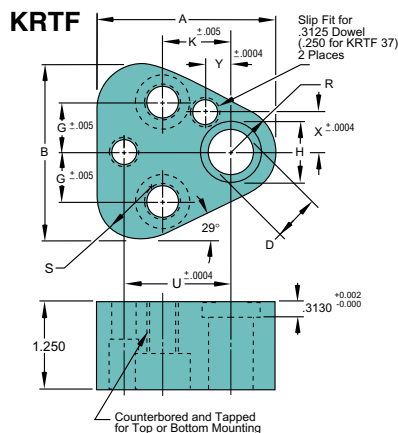

HOW TO ORDER

Specify: Qty. Catalog No.
Example: 13 KRTFS62
13 TRBP1663



Retainer sets include 2 dowels and 2 screws.

Catalog No.	Type	Code	D	A	B	KRTF H	G	K	KRTFS M	R	S	U	X	Y	Screw Size	Tapped Hole
		37	.3750	1.75	1.72	.59	.438	.750	.296	.38	.47	1.060	.3543	.2953	5/16-18	3/8-16
		50	.5000	2.00	1.97	.72	.563	.750	.359	.50	.60	1.180	.4724	.2559	5/16-18	3/8-16
		62	.6250	2.12	2.09	.84	.625	.750	.422	.56	.66	1.250	.5315	.2362	5/16-18	3/8-16
		75	.7500	2.37	2.34	.97	.688	.750	.484	.69	.79	1.320	.6496	.1968	5/16-18	3/8-16
		87	.8750	2.50	2.47	1.09	.688	.750	.546	.75	.85	1.400	.7284	.1970	5/16-18	3/8-16
		100	1.0000	2.75	2.72	1.22	.781	.938	.609	.88	.97	1.600	.8661	.2756	1/2-13	5/8-11

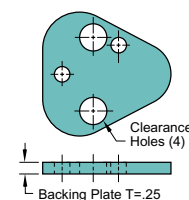

Backing Plate	
D	Catalog No.
37	TRBP 10 63
50	TRBP 13 63
62	TRBP 16 63
75	TRBP 20 63
87	TRBP 22 63
100	TRBP 25 63

TuffPunch® Jektole® Punches

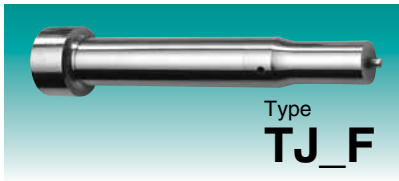

Type
TJ_F

Material

Steel: PS4 (CPM M4), RC 60-62
Heads RC 40-55

Round P $\pm .0005$ to $-.0000$ | P to D
Shape P, W $\pm .0005$ | P to D

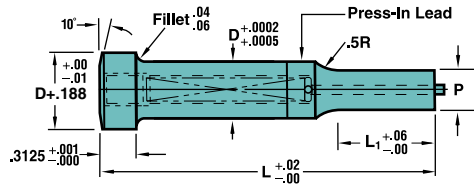

HOW TO ORDER

Specify: Qty. Type D Code L P (or P&W) Dimension
Example: 6 TJXF 37 C225 P.204

Note: The standard location of a key flat is parallel to the P dimension. For additional information, see p.7.

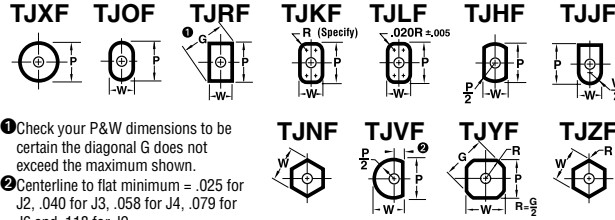
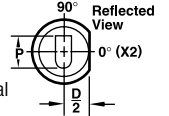

- 1 Check your P&W dimensions to be certain the diagonal G does not exceed the maximum shown.
- 2 Centerline to flat minimum = .025 for J2, .040 for J3, .058 for J4, .079 for J6 and .118 for J9.

Standard Alterations
See p.6 for additional ordering instructions.

Standard shapes with sharp corners will have a .005" radius to reduce loading on the punch.

Shank D	Code	Point Length L ₁			Round		Shape			L											Jektole® Group		
		A	B	C	Min. XP	Range P	Min. XW	Min. W	Max. P/G	2.00	2.25	2.50	2.75	3.00	3.25	3.50	3.75	4.00	4.25	4.50		4.75	5.00
.3750	37	.50	.75	1.00	.158	.158 - .3749	.158	.158	.375	200	225	250	275	300	325	350	375	400	425	450	475	500	J6
.4375	43	.50	.75	1.00	.158	.187 - .4374	.158	.187	.4375	200	225	250	275	300	325	350	375	400	425	450	475	500	J6
.5000	50	.50	.75	1.00	.158	.250 - .4999	.158	.187	.500	200	225	250	275	300	325	350	375	400	425	450	475	500	J6
.6250	62	.50	.75	1.00	.235	.375 - .6249	.235	.250	.625	200	225	250	275	300	325	350	375	400	425	450	475	500	J9
.7500	75	.50	.75	1.00	.300	.500 - .7499	.235	.312	.750	200	225	250	275	300	325	350	375	400	425	450	475	500	J9
.8750	87	.50	.75	1.00	.400	.562 - .8749	.235	.312	.875	200	225	250	275	300	325	350	375	400	425	450	475	500	J9
1.0000	100	.50	.75	1.00	.400	.625 - .9999	.235	.375	1.000	200	225	250	275	300	325	350	375	400	425	450	475	500	J9

Note: DayKool™ (XCR)—a cryogenic steel conditioning process used primarily with hard, thick materials to improve strength, toughness, and dimensional stability—is standard on all Dayton TuffPunch® products. For additional information, see p. 2.



TuffPunch® Jektole® Punch Blanks

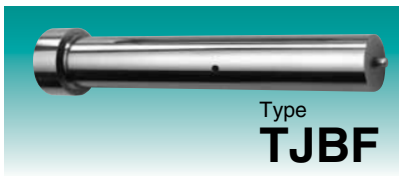

Type
TJBF

Material
Steel: PS4 (CPM M4), RC 60-62
Heads RC 40-55

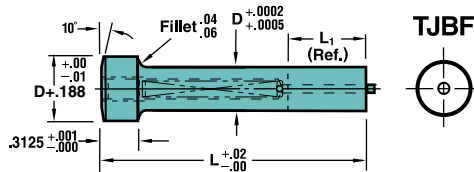

HOW TO ORDER

Specify: Qty. Type D Code L
Example: 9 TJBF 37 B200

Standard Alterations
See p.6 for additional ordering instructions.

Shank D	Code	Point Length L ₁			L											Jektole® Group		
		A	B	C	2.00	2.25	2.50	2.75	3.00	3.25	3.50	3.75	4.00	4.25	4.50		4.75	5.00
.3750	37	.50	.75	1.00	200	225	250	275	300	325	350	375	400	425	450	475	500	J6
.4375	43	.50	.75	1.00	200	225	250	275	300	325	350	375	400	425	450	475	500	J6
.5000	50	.50	.75	1.00	200	225	250	275	300	325	350	375	400	425	450	475	500	J6
.6250	62	.50	.75	1.00	200	225	250	275	300	325	350	375	400	425	450	475	500	J9
.7500	75	.50	.75	1.00	200	225	250	275	300	325	350	375	400	425	450	475	500	J9
.8750	87	.50	.75	1.00	200	225	250	275	300	325	350	375	400	425	450	475	500	J9
1.0000	100	.50	.75	1.00	200	225	250	275	300	325	350	375	400	425	450	475	500	J9

Note: DayKool™ (XCR)—a cryogenic steel conditioning process used primarily with hard, thick materials to improve strength, toughness, and dimensional stability—is standard on all Dayton TuffPunch® products. For additional information, see p. 2.



TuffPunch® Regular Punches

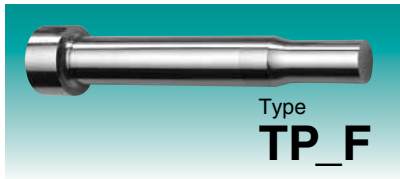

Type
TP_F

Material

Steel: PS4 (CPM M4), RC 60-62
Heads RC 40-55

Round P $\begin{matrix} +.0005 \\ -.0000 \end{matrix}$ $\begin{matrix} \text{P to D} \\ \text{P to D} \end{matrix}$
Shape P, W $\pm .0005$ $\begin{matrix} \text{P to D} \\ \text{P to D} \end{matrix}$

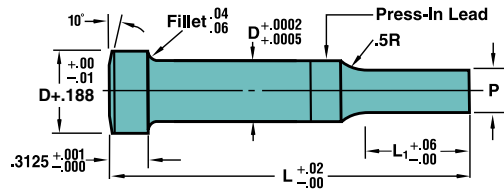

HOW TO ORDER

Specify: Qty. Type D Code L P (or P&W) Dimension
Example: 9 TPLF 100 B350 P.872, W.401

Note: The standard location of a key flat is parallel to the P dimension. For additional information, see p.7.

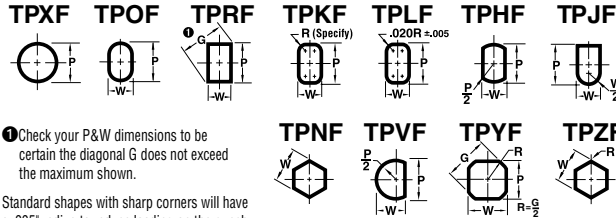
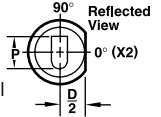

Check your P&W dimensions to be certain the diagonal G does not exceed the maximum shown.

Standard shapes with sharp corners will have a .005" radius to reduce loading on the punch.

Standard Alterations

See p.6 for additional ordering instructions.



Shank D	Code	Point Length L ₁			Round		Shape		L												
		A	B	C	Min. XP	Range P	Min. XW	Min. Max. W P/G	2.00	2.25	2.50	2.75	3.00	3.25	3.50	3.75	4.00	4.25	4.50	4.75	5.00
.3750	37	.50	.75	1.00	.062	.158 - .3749	.109	.158 - .375	200	225	250	275	300	325	350	375	400	425	450	475	500
					.093	.158 - .3749	.125	.158 - .375													
					.125	.158 - .3749	.125	.158 - .375													
.4375	43	.50	.75	1.00	.080	.187 - .4374	.109	.187 - .4375	200	225	250	275	300	325	350	375	400	425	450	475	500
					.109	.187 - .4374	.125	.187 - .4375													
					.125	.187 - .4374	.172	.187 - .4375													
.5000	50	.50	.75	1.00	.125	.250 - .4999	.125	.187 - .500	200	225	250	275	300	325	350	375	400	425	450	475	500
					.125	.250 - .4999	.141	.187 - .500													
					.125	.250 - .4999	.172	.187 - .500													
.6250	62	.50	.75	1.00	.235	.375 - .6249	.235	.250 - .625	200	225	250	275	300	325	350	375	400	425	450	475	500
					.235	.375 - .6249	.235	.250 - .625													
					.235	.375 - .6249	.235	.250 - .625													
.7500	75	.50	.75	1.00	.300	.500 - .7499	.235	.312 - .750	200	225	250	275	300	325	350	375	400	425	450	475	500
					.300	.500 - .7499	.235	.312 - .750													
					.300	.500 - .7499	.235	.312 - .750													
.8750	87	.50	.75	1.00	.350	.562 - .8749	.235	.312 - .875	200	225	250	275	300	325	350	375	400	425	450	475	500
					.350	.562 - .8749	.235	.312 - .875													
					.350	.562 - .8749	.235	.312 - .875													
1.0000	100	.50	.75	1.00	.400	.625 - .9999	.235	.375 - 1.000	200	225	250	275	300	325	350	375	400	425	450	475	500
					.400	.625 - .9999	.235	.375 - 1.000													
					.400	.625 - .9999	.235	.375 - 1.000													

Note: DayKool™ (XCR)—a cryogenic steel conditioning process used primarily with hard, thick materials to improve strength, toughness, and dimensional stability—is standard on all Dayton TuffPunch® products. For additional information, see p. 2.

TuffPunch® Regular Punch Blanks



Type
TPBF

Material

Steel: PS4 (CPM M4), RC 60-62,
Heads RC 40-55

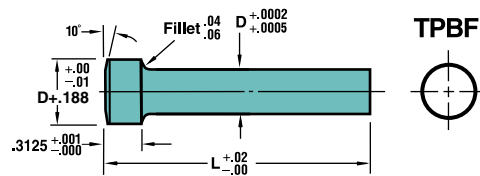

HOW TO ORDER

Specify: Qty. Type D Code L
Example: 9 TPBF 37 200

Standard Alterations

See p.6 for additional ordering instructions.



Shank D	Code	L												
		2.00	2.25	2.50	2.75	3.00	3.25	3.50	3.75	4.00	4.25	4.50	4.75	5.00
.3750	37													
.4375	43													
.5000	50													
.6250	62	200	225	250	275	300	325	350	375	400	425	450	475	500
.7500	75													
.8750	87													
1.0000	100													

Note: DayKool™ (XCR)—a cryogenic steel conditioning process used primarily with hard, thick materials to improve strength, toughness, and dimensional stability—is standard on all Dayton TuffPunch® products. For additional information, see p. 2.

Standard Alterations—Punches and Punch Blanks

Punches are available in sizes other than those listed in the front of the catalog.

Jektole® Regular, & Punch Blanks

XP, XW P & W Dimensions
Smaller than Standard

XBR (Straight Before Radius)
It is recommended that point lengths
be kept as short as possible for
optimum strength.

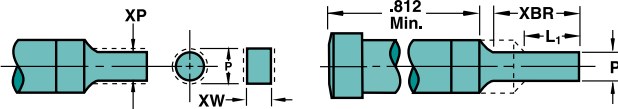

Code	Type	L ₁ Max.				Min. P (Rounds)				Min. W (Shapes)				Jektole® Group
		.500	.750	1.000	1.250	.500	.750	1.000	1.250	.500	.750	1.000	1.250	
37	*TJ	.158	.158	.158	.158	.158	.158	.172	.195	J6				
	TP	.062	.093	.125	.156	.109	.125	.125	.195					
43	*TJ	.158	.158	.158	.158	.158	.158	.172	.195	J6				
	TP	.080	.109	.125	.156	.109	.125	.172	.195					
50	*TJ	.158	.158	.158	.158	.158	.158	.172	.195	J6				
	TP	.125	.125	.125	.156	.125	.141	.172	.195					
62	TJ	.235	.235	.235	.235	.235	.235	.235	.235	J9				
	TP	.235	.235	.235	.235	.235	.235	.235	.235					
75	TJ	.300	.300	.300	.300	.235	.235	.235	.235	J9				
	TP	.300	.300	.300	.300	.235	.235	.235	.235					
87	TJ	.350	.350	.350	.350	.235	.235	.235	.235	J9				
	TP	.350	.350	.350	.350	.235	.235	.235	.235					
100	TJ	.400	.400	.400	.400	.235	.235	.235	.235	J9				
	TP	.400	.400	.400	.400	.235	.235	.235	.235					

*Specify XP or XW and XJ for TJ products.
The smaller minimum dimensions shown next to TP can be used.

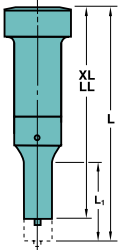

- XL** Overall Length Shortened (1.00 min.)
Stock removal from point end which shortens L₁ length.
- XLB** Overall Length Shortened
Stock removal from point end. Point length L₁ maintained.
(Min. shank length .75)
- LL** Precision Overall Length
Same as XL except overall length is held to ±.001.
- XK** No Side Hole
For air ejection. No cost.
- XS** Shear Angles
See information at right.
- XJ** Smaller Jektole Components

Shear Angles (XS)

TuffPunch® products are available in *common shear angle configurations* for all standard shapes.

Shear angles are available in any angle. Specify angle in whole degrees. If half degree is necessary, specify as a decimal, e.g., 8.5°. (Tolerance on all angles is ±15 minutes.) Use the chart below to determine the product designation, then simply add the alteration code shown next to the drawings, along with the angle desired. Example: TPXF 50, C300, P.400, XS20, A5°.

LL not available on XS19, XS21, XS22, and XS23.

For Round Punches Only

Views are reflected view.

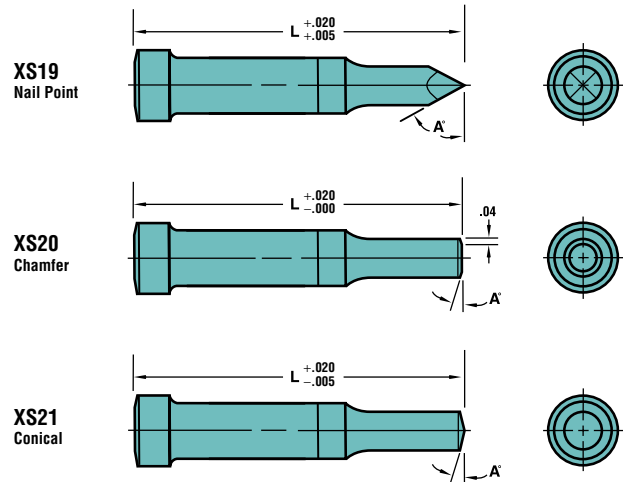

For Round and Shape Punches

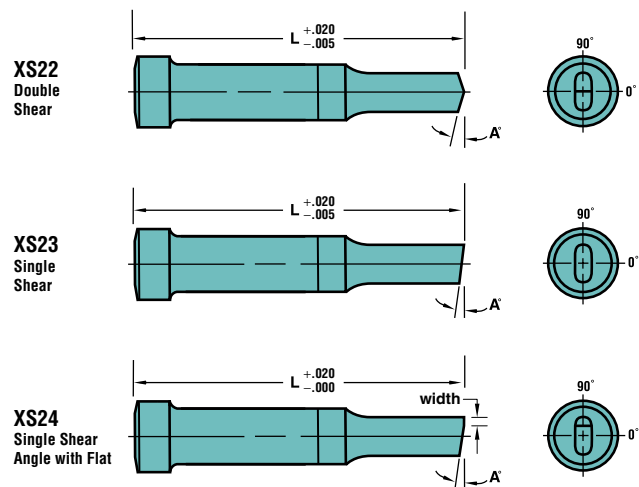

Coatings & Treatments

Code/Delivery			
XN —DayTride®	+ 3 days	XNM	+ 12 days
XVP	+ 3 days	XANL	+ 15 days
XPS	+ 0 days	XCD	+ 8 days
XNT —DayTiN®	+ 3 days	XCDH	+ 8 days
XCN —TiCN	+ 3 days	XCDP	+ 14 days
XAN —DayTAN™	+ 4 days	XNP	+ 8 days
XNA —ZertonPlus™	+ 7 days	XNAP— XNAPProgress	+ 12 days
		CRN	+ 7 days

See page 2 for additional coating information.

Locking Devices—Flats vs. Dowel Slots

Orientation

The standard location for all locking devices is 0°, and is always on the long side (P) of the shape. Custom locations are measured counterclockwise from 0°.

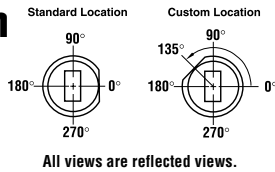

Standard and Alternate Locations

Standard Location is at 0°. **Alternate Location** is 90°, 180°, or 270°. Alternate locations are available at no additional charge.

Custom Locations

Custom Location is *any angle other than*: 0°, 90°, 180°, or 270°.

Single Flats

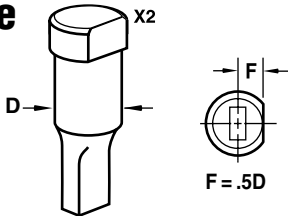

Single Flats: X2

Order Example: X2 — 90°

Single Flats: X5

Order Example: X5 — 135°

Double Flats

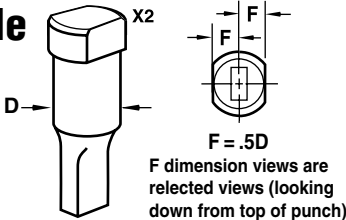

Double Flats: X3

Locking Devices: X3

Order Example: X3 — 90°

Second Flat is *always parallel* to the first flat.

Double Flats: X6

Locking Devices: X6

Order Example: X6 — 135°

Additional Flats

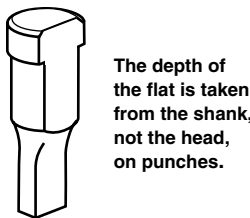

Additional Flats

Code	Depth	Length
X81	.060	.500
X82	.060	.625
X83	.060	.750
X84	.060	Full Length
X85	.093	.500
X86	.093	.625
X87	.093	.750
X88	.093	Full Length
X89	Specify Dimensions	

Additional Flats

Code	Depth	Length
X91	.060	.500
X92	.060	.625
X93	.060	.750
X94	.060	Full Length
X95	.093	.500
X96	.093	.625
X97	.093	.750
X98	.093	Full Length
X99	Specify Dimensions	

Dowel Slots

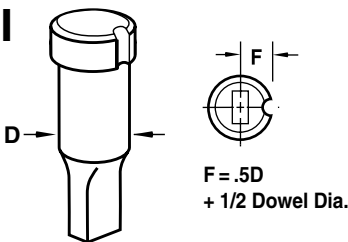

Dowel Slots: X4 & X41

For standard locations, specify **X4** (.125 Dowel) or **X41** (.1875 Dowel). For alternate locations, specify **X4** or **X41** and degree required.

Order Example: X4 — 90°

Dowel Slots: X7 & X71

Specify **X7** (.125 Dowel) or **X71** (.1875 Dowel). For custom locations, specify **X7** or **X71** and degree required.

Order Example: X71 — 135°

Location Tolerance

Flat		Dowel	
F	Radial	F	Radial
+ .0005	.001/ inch	+ .0005	0°4'
- .0000		- .0000	

How To Specify

The most common locking devices—flat, double flat, and dowel—are available. Simply select the type, then add the code to the component description.

HOW TO ORDER

Specify:	Qty.	Type	D Code	P (or P&W) Dimension	Locking Device
Example:	1	TJRF	37	P.321, W.189	X2

Commitment to Quality & Customer Satisfaction

Dayton Lamina is a leading manufacturer of tool, die and mold components for the metal-working and plastics industries. As a customer-focused, world-class supplier of choice, we provide the brands, product breadth, distribution network and technical support for all your metal forming needs.

Our goal is to give our customers the most innovative and value-added products and services.



DAYTON Lamina™

a MISUMI Group Company



Lamina® LEMPCO

*Dayton Lamina's line of Danly products is available only to North America.

www.daytonlamina.com